

PrimeTest 220

Operating Instructions

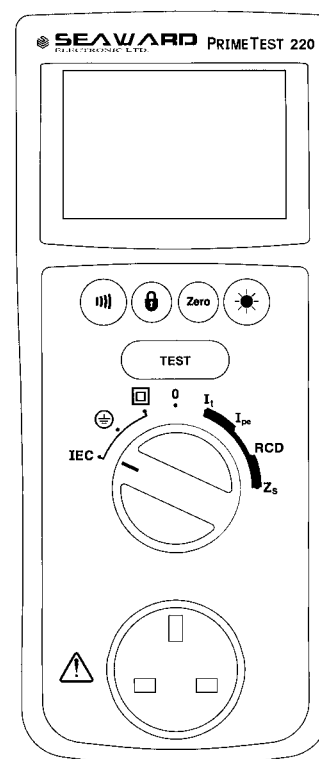

Bracken Hill, South West Industrial Estate,
Peterlee, Co. Durham SR8 2SW. England.

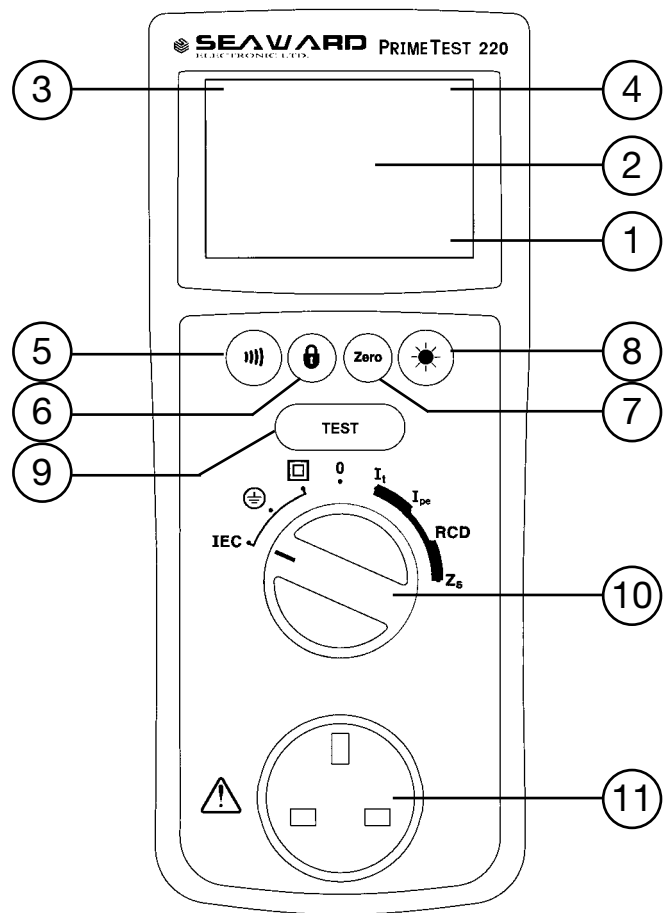

Fig 1.

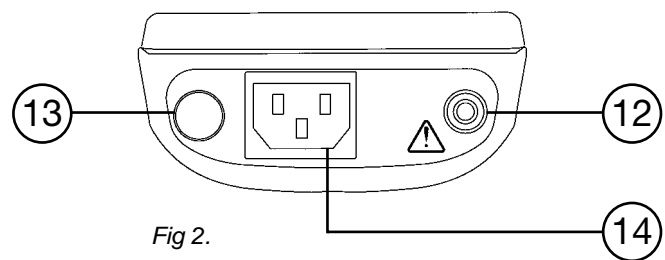

Fig 2.

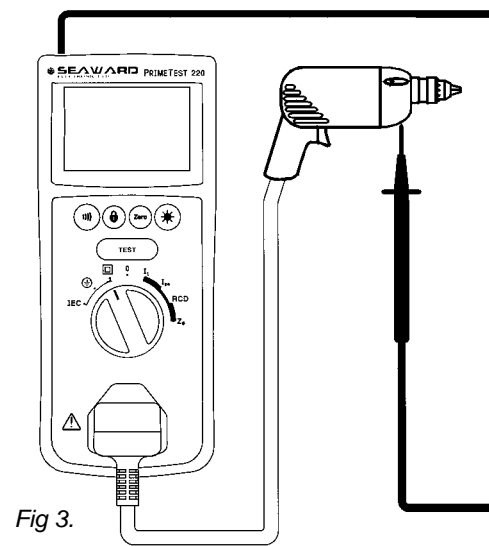

Fig 3.

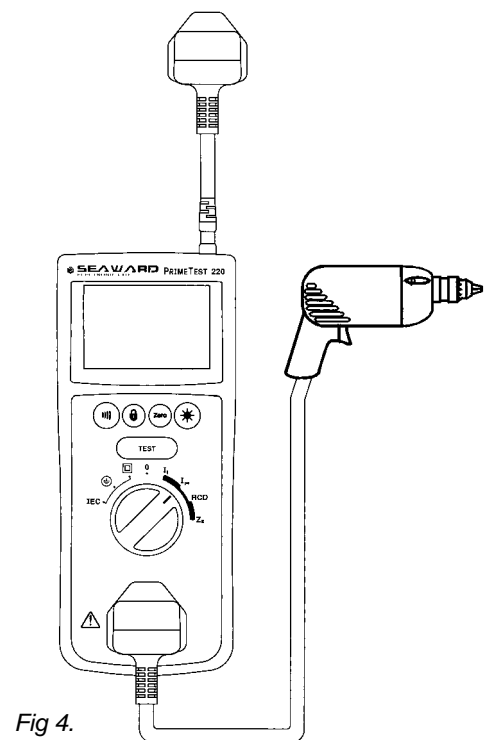

Fig 4.

Primetest 220

Operating Instructions

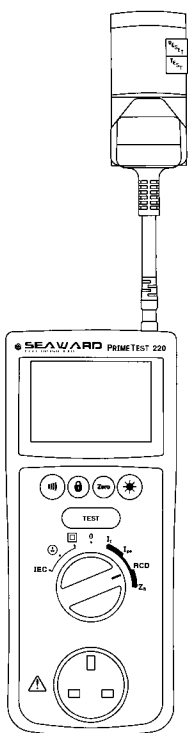

Fig 5.

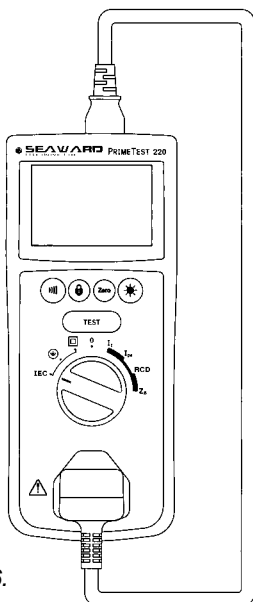

Fig 6.

Primetest 220

Operating Instructions

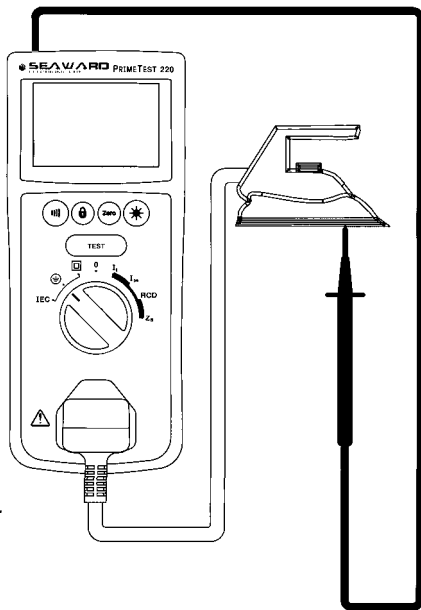

Fig 7.

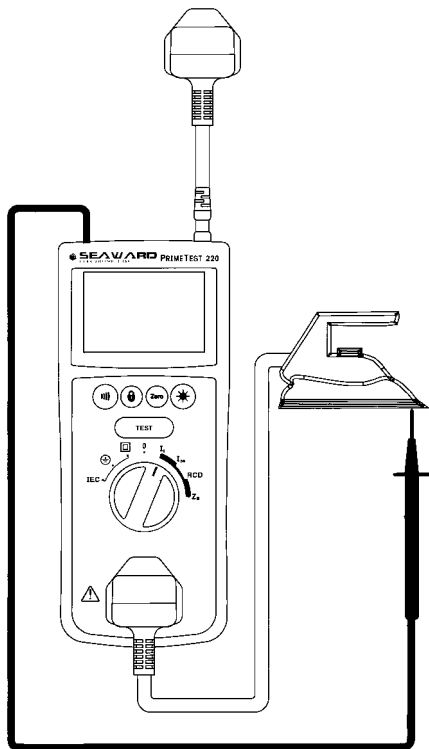

Fig 8.

Primetest 220

Operating Instructions

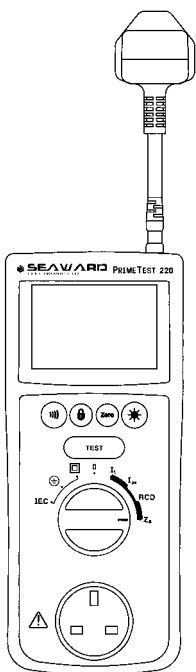

Fig 9.

Primetest 220

Operating Instructions

Limited Warranty & Limitation of Liability

SEAWARD Electronic Limited guarantees this product for a period of 1 year. The period of warranty will be effective at the day of delivery.

(c) Copyright 2005

All rights reserved. Nothing from this edition may be multiplied, or made public in any form or manner, either electronically, mechanically, by photocopying, recording, or in any manner, without prior written consent from SEAWARD Electronic Limited. This also applies to accompanying drawings and diagrams.

Due to a policy of continuous development SEAWARD Electronic Limited reserves the right to alter the equipment specification and description outlined in this publication without prior notice and no part of this publication shall be deemed to be part of any contract for the equipment unless specifically referred to as an inclusion within such contract.

Primetest 220

Operating Instructions

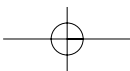
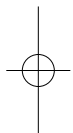
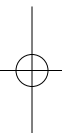

Primetest 220

Operating Instructions

**Operating Instructions
PrimeTest 220**

A multifunction testing instrument: used to perform comprehensive electrical safety tests on:

- Class I appliances
- Class II appliances
- IEC Leads

With the PrimeTest 220 connected to the mains supply using an IEC mains lead the following tests can be performed:

- Differential current
- Touch current
- RCD
- Earth loop resistance
- Power socket wiring check

Contents

- 1. User Notes**
- 2. Safety Notes**
- 3. Standard Accessories**
- 4. Description**
- 5. General Information**
- 6. Environmental conditions**
- 7. Electrical Specifications**
- 8. Operation of Test Functions**
- 9. Maintenance**

1.0 User Notes

These operating instructions are intended for the use of adequately trained personnel.

The PrimeTest 220 has been designed to make measurements in a dry environment. It must not be used for making measurements in electric circuits with nominal voltage greater than 300 V AC/DC.

Primetest 220

Operating Instructions

The following symbols are used in these operating instructions and on the PrimeTest 220.



Warning of electrical danger! Indicates instructions must be followed to avoid danger to persons.



Important, follow the documentation! This symbol indicates that the operating instructions must be adhered to in order to avoid danger.



This symbol on the PrimeTest 220 indicates that the unit can safety test Class II equipment. The PrimeTest 220 is not double insulated.



This symbol on the PrimeTest 220 indicates that the unit can safety test Class I equipment.



This symbol on the PrimeTest 220 indicates the built in fuse.

2.0 Safety Notes

This PrimeTest 220 has been built and tested in accordance with:

BS EN 61010 part 1.

BS EN 61557 part 1, 2, 4 and 10.

The PrimeTest 220 has left the factory in a perfectly safe state. To maintain this state and ensure safe operation of the unit, all notes and warnings in these instructions must be observed at all times.



This instrument may be used on electric circuits, which comply to over voltage category II. The ⚡ symbol warns the operator that a dangerous voltage is connected to the unit.

Primetest 220

Operating Instructions



The tester and all associated cables and leads must be checked for signs of damage before the equipment is operated.



Attention! During and Class I and Class II tests, high voltage levels occur within the PrimeTest 220.

Where safe operation of the tester is no longer possible, it should be immediately shutdown and secured to prevent accidental operation.

It must be assumed that safe operation is no longer possible:

- if the instrument or the measuring leads show visible signs of damage, or
- the tester does not function, or
- after long periods of storage under adverse environmental conditions.

Important

- Do not touch the bare probe tips of the measuring lead.

- Ensure the black measuring lead is plugged into the corresponding black socket on the PrimeTest 220

- Do not operate the PrimeTest 220 in an explosive gas or dust environment.

3.0 Accessories

3.1 Standard Accessories

The PrimeTest 220 is supplied with the following items:

- 3.1.1 1 off PrimeTest 220
- 3.1.3 1 off 1.2 M test lead black
- 3.1.5 1 off alligator clip, black
- 3.1.6 1 off mains cord
- 3.1.7 1 off professional carry case
- 3.1.8 6 off alkaline batteries 1.5 AA size LR6
- 3.1.9 1 off operating instruction manual

Primetest 220

Operating Instructions

3.2 Optional Accessories

It should be noted that the following parts of the PrimeTest 220 are user serviceable and must be replaced with appropriate parts as detailed below:

- 1 off fuse, nominal current rating 12.5 A, 500 V AC, Anti Surge, (27B111).



Do not open unit, no other serviceable parts.

4.0 Description

The display and selectable functions of the PrimeTest 220 are specified below in conjunction with Figure 1 and Figure 2.









4.1 Rotary Switch

- 1) Test function **0** is the PrimeTest 220 power off position.
- 2) Test function \oplus selects the Class I safety test (earth continuity, insulation resistance) test.
- 3) Test function I_{Δ} selects the differential leakage current test for Class I equipment. Requires mains from power cord.
- 4) Test function RCD selects the RCD test. Requires mains from power cord.
- 5) Test function IEC selects the IEC lead (earth continuity, insulation resistance, wire check) test.
- 6) Test function \square selects the Class II safety test (insulation resistance).
- 7) Test function I_t selects the touch current test for Class II equipment. Requires mains from power cord.
- 8) Test function **Zs** selects the earth loop impedance test. Requires mains from power cord.

Primetest 220

Operating Instructions











4.2 LCD and Keypad

- 1) Digital display for all measurement readings and polarity indication.
- 2) Small digital display used to indicate Pass/Fail criteria or secondary test requirements for selectable test functions e.g. Polarity.
- 3) Battery indicator -  symbol is illuminated depending on battery health status (see section 5.6).
- 4)  button, enables or disables the audio buzzer. When selected the  symbol is illuminated on the LCD display. The audible alarm is activated as an audio representation of either a PASS or a FAIL condition.
- 5)  button, enables or disables the lock function and allows test parameters for I_{pe} and I_t to be applied up to 30 seconds (see section 8.2.6 and 8.6.8). When selected the  symbol is illuminated on the LCD display.
- 6)  button compensates for the test lead resistance in Class I safety test. When selected the  symbol is illuminated on the LCD display.
- 7)  button, switches the display illumination on or off.
- 8)  button is used to start tests and activate the RCD and **Zs** measuring functions.
- 9) Rotary switch selects the required test function (see section 4.1).
- 10) Equipment under test (EUT) socket.
- 11) Negative (black) socket.
- 12) Mains input socket.
- 13) IEC test socket.

Primetest 220

Operating Instructions

5.0 General Information

- 5.1 Range overflow of the digital display ① is automatic and is indicated by the greater than symbol >.
- 5.2 The  button ⑥ allows a 30 second measurements of I_t and I_{pe} without the need to repeatedly press the  button. To activate the continuous test mode the operator must press and hold the  button down then simultaneously press the lock  button down. Both buttons can then be released in any order. The  symbol will be illuminated on the LCD display. The operator can deactivate the  mode by pressing either the  or  buttons.
- 5.3 The PrimeTest 220 will automatically switch off after a period of 5 minutes with no push button or switch action. Where the  mode is enabled the automatic shutdown period is 3 minutes. When a subsequent push button or switch action takes place the instrument automatically switches itself on again.
- 5.4 When the PrimeTest 220 is switched on from power off position 0 to another switch position, an on load battery test occurs. The result of this test determines the available battery capacity. A healthy battery results in no battery symbol being illuminated on the LCD display. A deteriorating battery results in the  symbol being illuminated in the steady state. An unhealthy battery results in a flashing  symbol.

When the flashing  symbol is displayed all test and measurement functions are inhibited to avoid endangering persons by recording false measurements.

- 5.5 During the protective earth conductor current I_{pe} and touch leakage I_t test functions it is possible that a RCD could be tripped due to the inadvertent testing of a defective EUT.

Primetest 220

Operating Instructions

5.6 Dimensions of the PrimeTest 220 are 265 x 108 x 55mm (L x W x H)

6.0 Environmental Conditions

6.1 The PrimeTest 220 has been designed to perform tests and measurements in a dry environment.

6.2 Maximum barometric elevation for making measurements is 2000M.

6.3 Overvoltage category IEC 60664/IEC 61010, 300V Category II.

6.4 Contamination degree 2 according to IEC 61010-1.

6.5 Protective system IP40 according to IEC 60529.

6.6 Electromagnetic compatibility (EMC). Interference immunity and emitted interference conforming to IEC 61326-1.

6.7 Operating temperature range of 0°C to 40°C, without moisture condensation.

6.8 The PrimeTest 220 can be stored at any temperature in the range -25°C to +65°C (relative humidity up to 90%). The batteries should be taken out of the instrument for storage.

7.0 Electrical Specification**7.1 Earth continuity measuring range (rotary switch position \oplus , and IEC)**

Measuring Range	Resolution	Accuracy	Overload Protection
19.99Ω	0.01Ω	±5% ±2 digits	300 V AC/DC

Open circuit voltage >4VDC
Test current >220mA (0-2Ω)

The maximum number of continuity tests, with a duty cycle specified by BS EN 61557-4 Section 6.6, is 1900 repetitions.

Primetest 220

Operating Instructions

7.2 Insulation resistance measuring range (rotary switch position \oplus , \square , IEC and M Ω).

Measuring Range	Resolution	Accuracy	Overload Protection
2M Ω	0.01M Ω	$\pm 2\% \pm 2$ digits	300 V AC/DC
20M Ω	0.1M Ω	$\pm 5\% \pm 2$ digits	300 V AC/DC
200M Ω	1M Ω	$\pm 10\% \pm 2$ digits	300 V AC/DC

Test voltage	500VDC at 1mA, <750VDC for o/c
Test voltage accuracy	+20%, -0%
Test current	<2mA for s/c

The maximum number of insulation tests, with a duty cycle specified by BS EN 61557-2 Section 6.7, is 2000 repetitions.

7.3 IEC lead test

The IEC lead test is a sequence of earth continuity measurement (section 7.1) - insulation resistance measurement (section 7.2) - Live/Neutral checks for o/c, s/c and crossed conductors in the IEC lead.

Test voltage	9 VDC
Test duration	10 seconds

7.4 Touch current measurement

Measuring Range	Resolution	Accuracy	Overload Protection
3.5mA	0.01mA	$\pm 10\% \pm 2$ digits (5° - 40°) $\pm 15\% \pm 2$ digits (0° - 5°)	N/A

Test voltage	mains supply @ 230V - 15%/+10% @ 10A max
Frequency	50Hz $\pm 1\%$
Test duration	2 seconds minimum
Frequency response	IEC 61010-1 Annex A.1

The test is disabled when phase-neutral (PN) or phase-earth (PE) voltage is not at mains potential or a voltage of 40 V AC or greater exists between neutral-earth (NE).

Primetest 220

Operating Instructions

7.5 Protective earth conductor current measurement

Measuring Range	Resolution	Accuracy	Overload Protection
19.99mA	0.01mA	±5% ±2 digits	N/A

Test voltage	mains supply @ 230V - 15%/+10% @ 10A max
Frequency	50Hz ±1%
Test duration	2 seconds minimum
Frequency response	IEC 61010-1 Annex A.1 (from 40Hz)

The test is disabled when phase-neutral (PN) or phase-earth (PE) voltage is not at mains potential or a voltage of 40 V AC or greater exists between neutral-earth (NE).

7.6 RCD test

Test current	30mA r.m.s
Test current accuracy	+5%, - 0%
Test duration	500ms maximum if RCD does not trip
Trip time accuracy	0mS to 40mS, ±2mS 41mS to 500mS, ±5mS

The test is disabled when phase - neutral (PN) or phase-earth (PE) voltage is not at mains potential or a voltage of 40 VAC or greater exists between neutral - earth (NE).

7.7 Zs test

Measuring Range	Resolution	Accuracy	Overload Protection
19.9Ω	0.1Ω	±10% ±2 digits	N/A
199Ω	1Ω	±10% ±2 digits	N/A

Test current	Such that it will not trip a 30mA RCD
Test voltage	230VAC +10%, -15%



The test is disabled when phase-neutral (PN) or phase-earth (PE) voltage is not at mains potential or a voltage of 40VAC or greater exists between neutral-earth (NE).

Primetest 220

Operating Instructions

8.0 Operation of test functions**8.1 Safety test, Class I** 

See figure 7



8.1.1 Select the Class I  test function on the rotary switch . Ensure the IEC mains lead is disconnected from the PrimeTest 220.



8.1.2 The LCD will display a probe signal to indicate that an earth bond test lead is required. This test function is selected when the equipment to be tested is fitted with a protective earth conductor.

8.1.3 Plug the equipment under test (EUT) into the EUT socket  on the front of the PrimeTest 220.

8.1.4 Plug the black test lead into the black socket  on the PrimeTest 220.

8.1.5 Connect the other end of the black test lead to exposed metalwork on the EUT.

8.1.6 To start a Class I safety test sequence, press the  button .

8.1.7 The earth continuity resistance for the EUT is measured at $\pm 200\text{mA}$. The large display  indicates the highest digital earth resistance, Ω , the small display  indicates a PASS/FAIL status. An additional visual display of a \checkmark or \times also indicates the PASS/FAIL status.

8.1.8 Earth continuity resistance value is held on the LCD display for a period of 1 second. A PASS or FAIL indication will be shown, depending on value of the displayed reading.

8.1.9 An earth continuity resistance that fails will terminate the Class I PAT test, a PASS will automatically sequence to the insulation resistance test.

Primetest 220

Operating Instructions



During an insulation resistance measurement a high voltage is applied between the Live/Neutral and Earth of the EUT. It should be noted that this voltage can also be present on the bare metalwork of the EUT.

8.1.10 The insulation resistance of the EUT is measured over a period of 2 seconds. The large display (2) indicates digital insulation resistance, $M\Omega$, the small display (3) indicates a PASS/FAIL status. An additional visual display of a \checkmark or a \times also indicates PASS/FAIL status.

8.1.11 The insulation resistance value will remain displayed until another rotary switch action.

8.2 Protective Earth Conductor Current I_{pe}

See figure 4.



Attention - The Black 4mm test socket must not be used whilst the PrimeTest 220 is performing a leakage test. Electric Shock Danger.



Attention - before a protective earth conductor current test is performed on a Class I EUT the operator must ensure that the EUT has already passed a Class I safety test.



Attention - An RCD may be triggered if the EUT is defective.



Warning - it is important that the user verifies that an appliance with moving parts (e.g. an electric drill) is safely mounted to allow movement without causing damage to equipment or personnel.

8.2.1 Plug the supplied mains power lead into the mains power socket (13) on the PrimeTest 220 .

8.2.2 Plug the other end of the supplied mains power lead into a mains power socket.

Primetest 220

Operating Instructions

- 8.2.3 Plug the equipment under test (EUT) into the EUT socket (11) on the front of the PrimeTest 220
- 8.2.4 Select the protective earth conductor current test function, I_{pe} on the rotary switch (10).
- 8.2.5 When the **TEST** button (9) is pressed the PrimeTest 220 checks the wiring of the power socket being used. If the line potentials are correct then the LCD will display the symbols PE and PN in the steady state. Where a fault exists, then the appropriate symbol will flash (see Appendix 1) along with the ⚡ symbol being displayed in the steady state. A fault condition will inhibit the differential leakage current test.



If a power test is selected but the mains supply has not been connected to the PrimeTest 220 then PE and PN symbols will flash and the test is inhibited.

- 8.2.6 To start the differential leakage test, press the **TEST** button (9). Mains power is applied to the EUT for a period of 2 seconds.
- 8.2.7 Where a longer protective earth conductor current test is required the operator must press and hold the **TEST** button down, then simultaneously press the lock (1) button down. Mains power is applied to the EUT for a period of up to 30 seconds. The operator can deactivate the (1) mode and end the test by pressing the (1) button.
- 8.2.8 The large digital display (2) indicates the differential leakage current, in mA, the small digital display (3) indicates a PASS/FAIL status. An additional visual display of a ✓ or ✗ also indicate the PASS/FAIL status.
- 8.2.9 The differential leakage current will remain displayed until another rotary switch or push button action.

Primetest 220

Operating Instructions



Attention - the protective earth conductor current measurement can be affected by exposure of the PrimeTest 220 to magnetic fields or current being absorbed by the EUT during differential leakage measurements.



Attention - where the input current waveform displays a crest factor of 2 then a percentage error of 2.2% is recorded on the PrimeTest 220 measured value.

8.3 Residual Current Device, RCD, Test

See figure 5



Attention - The Black 4mm test socket must not be used whilst the PrimeTest 220 is performing an RCD test. Electric Shock Danger!

8.3.1 Plug the supplied mains power lead into the mains power socket **(13)** on the PrimeTest 220.

8.3.2 Plug the other end of the supplied mains power lead into a mains power socket.

8.3.3 Select the RCD test function on the rotary switch **(10)**.

8.3.4 Switch on the mains power.

8.3.5 The PrimeTest 220 automatically checks the wiring of the power socket being used. If the line potentials are correct then the LCD will display the symbols PE and PN in the steady state. Where a fault exists then the appropriate symbol will flash (see Appendix 1) along with the ⚡ symbol being displayed in the steady state. A fault condition will inhibit the RCD test.



If a power test is selected but the mains supply has not been connected to the PrimeTest 220 then PE and PN symbols will flash and the test is inhibited.

Primetest 220

Operating Instructions

- 8.3.6 To start the RCD test, press the **TEST** button (9).
- 8.3.7 The PrimeTest 220 will produce a test current of 30mA r.m.s. between the live and protective earth of the supply. The test will commence at the start of a positive half cycle.
- 8.3.8 The RCD will trip. The time taken to trip for the positive half cycle, or the default time if no trip occurred is displayed on the PrimeTest 220.
- 8.3.9 A flashing RCD time and displayed 7 indicates that the RCD has failed to trip within 500ms.
- 8.3.10 Re-apply power to the PrimeTest 220 by resetting the RCD and press the **TEST** button (9).
- 8.3.11 The PrimeTest 220 will produce a test current of 30mA r.m.s. between the live and protective earth of the supply. The test will commence at the start of a negative half cycle.
- 8.3.12 The RCD will trip. The time taken to trip for the negative half cycle, or the default time if no trip occurred is displayed on the PrimeTest 220.
- 8.3.13 A flashing RCD time and displayed 7 indicates that the RCD has failed to trip within 500ms.
- 8.3.14 The RCD trip time will remain displayed until another rotary switch or push button action.

8.4 IEC Lead TEST, IEC

See Figure 6.

- 8.4.1 Select the IEC test function on the rotary switch (10)



Do not connect the IEC lead to the PrimeTest 220, in preparation for an IEC lead test, before the unit is switched on. Failure to comply will result in an error message displayed on the LCD.

Primetest 220

Operating Instructions

8.4.2 To test IEC leads connect the IEC socket side of the lead into the IEC plug (14). Connect the mains plug side of the lead into the EUT socket (11).

8.4.3 To start an IEC lead test press the **TEST** button (9).

8.4.4 The earth continuity resistance for the lead is measured at $\pm 200\text{mA}$. The large display (2) indicates the highest digital earth resistance, Ω . An earth continuity resistance $>20\ \Omega$ will result in a FAIL. An additional visual display of a \checkmark or \times also indicates the PASS/FAIL status.

Attention - 13A IEC or extension leads of different cable lengths will have different resistances. As a rule of thumb:-



12 metres of 13A cable	0.2Ω
6 metres of 13A cable	0.1Ω
3 metres of 13A cable	0.05Ω

8.4.5 The earth continuity resistance value is held on the LCD display for a period of 1 second.

8.4.6 An earth continuity resistance that FAILS will terminate the IEC lead test, otherwise it will automatically sequence to the insulation resistance test.



During an insulation resistance measurement a high voltage is applied between the LIVE/Neutral and common of the IEC lead.

8.4.7 The insulation resistance of the lead is measured over a period of 2 seconds. The large display (2) indicates digital insulation resistance, $\text{M}\Omega$, the small display (3) indicates a PASS/FAIL status. An additional visual display of a \checkmark or \times also indicates PASS/FAIL status.

8.4.8 Insulation resistance value is held on the LCD display for a period of 1 second. The displayed resistance value will flash if a FAIL and remain steady if a PASS.

Primetest 220

Operating Instructions

8.4.9 An insulation resistance that fails will terminate the lead test, a pass will automatically sequence to the lead wiring test and the small digital display ③ will indicate "LEAD".

8.4.10 The wiring of the IEC lead is tested over a period of 2 seconds. The large digital display ② indicates a PASS/FAIL status for the lead. An additional visual indication of a ✓ or X also indicates PASS/FAIL status.



The IEC lead wiring test checks for open circuit, short circuit or crossed wires within the IEC lead.

8.4.11 If this is the last IEC lead test or the only test then the results will remain displayed until another rotary switch or push button action.

8.5 Safety Test, Class II

See Figure 3

8.5.1 Select the Class II test function on the rotary switch ⑩. The LCD will display a probe symbol to indicate that a safety test lead is required. Ensure the IEC mains lead is disconnected from the PrimeTest 220.

8.5.2 Plug the equipment under test (EUT) into the EUT socket ⑪ on the front of the PrimeTest 220.

8.5.3 Plug the black insulation test lead into the black, socket ⑫ on the PrimeTest 220.

8.5.4 Connect the other end of the black insulation test lead to any exposed metal parts on the outer cover of the EUT or near the mains input or mains switch if there are no exposed metal parts.

8.5.5 To start a Class II safety test, press the **TEST** button ⑨.

Primetest 220

Operating Instructions



During an insulation resistance measurement a high voltage is applied between the Live/Neutral of the EUT and the black test probe. It should be noted that this voltage can also be present on bare metalwork of the EUT.

8.5.6 The insulation resistance of the EUT is measured over a period of 2 seconds. The large display (2) indicates a digital insulation $M\Omega$, the small display (3) indicates a PASS/FAIL status. An additional visual display of a \checkmark or \times also indicates PASS/FAIL status.

8.5.7 Insulation resistance value is held on the LCD display for a period of 1 second. The displayed insulation resistance will flash if a FAIL and remain steady if a PASS.

8.5.8 The result will remain displayed until another rotary switch or pushbutton action.

8.6 Touch Leakage Current, I_t

See figure 8



Attention - before a touch leakage current test is performed on a Class II EUT the operator must ensure that the EUT has already passed a Class II safety test.



Attention - An RCD may be triggered if the EUT is defective.



Warning - It is important that the user verifies that an appliance with moving parts (e.g. an electric drill) is safely mounted to allow movement without causing damage to equipment or personnel.

8.6.1 Plug the supplied mains power lead into the mains power socket (13) on the PrimeTest 220.

8.2.2 Plug the other end of the supplied mains power lead into a mains power socket.

Primetest 220

Operating Instructions

- 8.6.3 Select the touch leakage current test function on the rotary switch (10). The LCD will display a probe signal to indicate that a safety test lead is required.
- 8.6.4 Plug the equipment under test into the EUT socket (11) on the front of the PrimeTest 220.
- 8.6.5 Plug the black test lead into the black socket (12) on the PrimeTest 220.
- 8.6.6 Connect the other end of the black test lead to exposed metalwork on the EUT.
- 8.6.7 When the **TEST** button (9) is pressed the PrimeTest 220 checks the wiring of the power socket being used. If the line potentials are correct then the LCD will display the symbols PE and PN in the steady state. Where a fault exists then the appropriate symbol will flash (see Appendix 1) along with ⚡ symbol being displayed in the steady state. A fault condition will inhibit the touch leakage test.
-  **If the power test is selected but the mains supply has not been connected to the PrimeTest 220 then PE and PN symbols will flash and the test is inhibited.**
- 8.6.8 To start the touch leakage test, press the **TEST** button (9). Mains power is applied to the EUT for a period of 2 seconds.
- 8.6.9 When a longer touch leakage test is required the operator must press and hold the **TEST** button down, then simultaneously press the lock (i) button down. Mains power is applied to the EUT for a period of up to 30 seconds, The operator can deactivate the (i) mode and end the test by pressing the (i) button.
- 8.6.10 The large digital display (2) indicates the touch leakage current, in mA, the small digital display (3) indicates a PASS/FAIL status. An additional visual display of a ✓ or ✗ also indicates the PASS/FAIL status.

Primetest 220

Operating Instructions

8.6.11 The touch leakage current will remain displayed until another rotary switch or pushbutton action.

8.7 Earth Loop Impedance, Z_s , Test

See Figure 9.

8.7.1 Plug the supplied mains power lead into the mains power socket (13) on the PrimeTest 220.

8.7.2 Plug the other end of the supplied mains power lead into a mains power socket.

8.7.3 Select the **Z_s** test function on the rotary switch (10)

8.7.4 Switch on the mains power.

8.7.5 The PrimeTest 220 automatically checks the wiring of the power socket being used. If the line potentials are correct then the LCD will display the symbols PE and PN in the steady state. Where a fault exists then the appropriate symbol will flash (see Appendix 1) along with the ⚡ symbol being displayed in the steady state. A fault condition will inhibit the **Z_s** test.



If a power test is selected but the mains supply has not been connected to the PrimeTest 220 then PE and PN symbols will flash and the test is inhibited.

8.7.6 To start an earth loop impedance test press the **TEST** button (9).

8.7.7 The large display (2) indicates a digital resistance value, in Ω .

8.7.8 The earth loop impedance value will remain displayed until another rotary switch or push button action.

Primetest 220

Operating Instructions

9.0 Maintenance

**Before opening the PrimeTest 220 ensure that it is disconnected from all voltage!
Electric shock danger!**

9.1 Preparing to work on the PrimeTest 220.

Make the PrimeTest 220 voltage free as follows, before opening the instrument.

9.1.1 Disconnect the test lead from the measuring point.

9.1.2 Disconnect the mains power cable from the PrimeTest 220.

9.1.3 Remove the test lead from the PrimeTest 220.

9.1.4 Select the test function **0**, power off position, on the rotary switch **①**.

9.2 Securing the PrimeTest 220

Under certain conditions safe operation of the PrimeTest 220 can no longer be assumed.

9.2.1 Visible damage of the instrument case.

9.2.2 Incorrect measurement results.

9.2.3 Recognisable abuse to the instrument due to prolonged storage under improper conditions.

9.2.4 Recognisable abuse to the instrument due to extraordinary transportation stress.

9.2.5 In these cases, the PrimeTest 220 should be immediately switched off, disconnected from any test or measurement function and secured to prevent any further use.

Primetest 220

Operating Instructions

9.3 Cleaning

- 9.3.1 Clean the external case of the PrimeTest 220 with a clean dry cloth.
- 9.3.2 Avoid using solvents and abrasive scouring agents to clean the external case of the PrimeTest 220.
- 9.3.3 Check the battery contacts and compartment are free of electrolytic contamination.
- 9.3.4 Any contamination of the battery contacts or compartment should be cleaned with a dry cloth.

9.4 Battery Replacement



**Before opening the PrimeTest 220 ensure that it is disconnected from all voltage!
Electric shock danger!**

When the  symbol is displayed the batteries of the PrimeTest 220 must be replaced (See section 5.6). Replace the batteries as follows:

- 9.4.1 Disconnect the test lead from the measuring point.
- 9.4.2 Disconnect the mains cable from the PrimeTest 220.
- 9.4.3 Remove the test lead from the PrimeTest 220.
- 9.4.4 Select the test function 0, power off position on the rotary switch .
- 9.4.5 Position the PrimeTest 220 face down and release the captive screw in the battery compartment cover.
- 9.4.6 Remove the battery compartment cover.
- 9.4.7 Remove the discharged batteries from the compartment.

Primetest 220Operating Instructions

9.4.8 Insert a new set of batteries into the battery compartment ensuring that the battery polarity matches the marking on the inside of the battery compartment.

9.4.9 Relocate the battery cover over the battery compartment and fasten in position with the battery cover captive screw.



This meter contains NiMH batteries. Do not dispose of these batteries with other solid waste. Used batteries should be disposed of by a qualified recycler or hazardous materials handler.

9.6 Checking the EUT Socket Fuse.

9.6.1 Plug the PrimeTest 220 into the mains power socket, using the mains lead provided.

9.6.2 Select one of the four power tests, protective earth conductor current I_{pe} , touch leakage current I_t , RCD trip or earth loop impedance test Z_s . on the rotary switch 

9.6.3 If the fuse is intact then the symbols PE, PN or NE will be displayed in the appropriate manner (see section 8.2.4) depending on the configuration of the power socket being used.

9.6.4 If the fuse is defective then the symbols PE, PN and NE will all flash on the display.

9.7 Replacing the Fuse.



**Before opening the PrimeTest 220 ensure that it is disconnected from all voltages!
Electric shock danger!**



The replacement fuse type is specified for ratings and size on the battery compartment cover on the rear of the PrimeTest 220.

Primetest 220

Operating Instructions

- 9.7.1 Disconnect the test lead from the measuring point.
- 9.7.2 Disconnect the mains cable from the PrimeTest 220.
- 9.7.3 Remove the test lead from the PrimeTest 220.
- 9.7.4 Select the test function **0**, power off position on the rotary switch ①.
- 9.7.5 Position the PrimeTest 220 face down and release the captive screw in the battery compartment.
- 9.7.6 Remove the battery compartment cover.
- 9.7.7 Lift one end of the defective fuse out of the fuse holder with the help of a flat bladed screwdriver.
- 9.7.8 Lift the defective fuse completely out of the fuse holder.
- 9.7.9 Insert a new fuse as described and specified by the text on the battery compartment cover.
- 9.7.10 Ensure that the new fuse is seated and centred in the fuse holder.
- 9.7.11 Relocate the battery cover over the battery compartment and fasten in position with the battery cover captive screw.

9.8 Calibration.

To maintain the specified accuracy of the measurement results, the instrument must be recalibrated at regular intervals by either the manufacturer or an authorised Seaward Service Agent. We recommend a recalibration period of one year.

Primetest 220

Operating Instructions

9.9 Spare Parts.

Fuse 31.75mm x 6.35mm 12.5A 250V Type T	Seaward Part No: 27B111
Test Leads (with alligator clips)	Seaward Part No: 44B124
Carry Case	Seaward Part No: 71G082

Appendix 1**PrimeTest 220 Diagnostic Indications****Mains Supply Icons**

PE	PN	NE	
Flash	Flash	Off	The mains supply is too high, too low or not present. These icons can also indicate a fault on RLY2.
Flash	On	Flash	Earth Open - Circuit
On	Flash	Flash	Neutral Open - Circuit

Err 1

The PrimeTest 220 has failed one of the Earth Relay Pre-Check tests. Contact your local service agent.

Err 2

The PrimeTest 220 has failed one of the Safety Relay Pre-Check tests. Contact your local service agent.

Err 3

The PrimeTest 220 has failed an Internal Relay Pre-Check test. Contact your local service agent.

Err 4

Preload safety test has failed. EUT load too high.

Err 5

The PrimeTest 220 has failed an Internal Relay Pre-Check test. Contact your local service agent.

Primetest 220

Operating Instructions

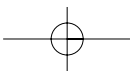
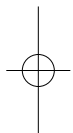
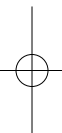

Primetest 220

Operating Instructions

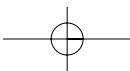
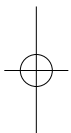
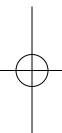

Primetest 220

Operating Instructions

